

AERIS PATIO DOORS



AERIS™

PATIO DOORS

THE BEAUTY OF WOOD INSIDE

THE PROFESSIONAL WAY

ProVia® has developed a competitive position by catering to a niche market that demands a high degree of customization coupled with superior quality. You will find attention to detail is what our customers have come to appreciate and expect from us. We're building your products and our company to last a lifetime...that's **The Professional Way**.

**MULTI
TIME**

Partner of the
Year Award



90%+

of Windows and Doors
are ENERGY STAR®
Certified

**remodeling
BRAND
LEADER**

#1 Quality
Rating
Vinyl
Windows

DOORS | WINDOWS | SIDING | STONE | ROOFING



6 Facilities in the United States

1,000+

Associates Nationwide

OUR MISSION
**TO SERVE
BY CARING FOR
DETAILS**
IN WAYS OTHERS WON'T

Doing Business Since

1977

19

Core Values

200+

Metric Tons of CO²
Saved Annually

1,900+

Tons of metals, paper, glass and vinyl
recycled annually at ProVia facilities

Visit provia.com to explore all of our products and options or
download the app.





INDUSTRY ASSOCIATION

ProVia is a proud member of the Window & Door Manufacturers Association, which promotes the standards of excellence in the residential window and door industry, and advances these standards among industry businesses with resources designed to provide greater value for their customers.



ACCREDITATION AND TESTING

ProVia's products are voluntarily third party tested and rated in several energy performance categories through the National Fenestration Rating Council and meet or exceed standards governed by the American Architectural Manufacturers Association.



ENERGY STAR®

ProVia manufactures energy efficient products and exercises environmental stewardship by recycling, reducing pollution emissions and much more. In fact, our company has received repeated awards from the Environmental Protection Agency such as Partner of the Year - Sustained Excellence for outstanding efforts in energy savings.



TABLE OF CONTENTS

Why Choose Wood-Clad Vinyl.....	3
Features.....	4
Screen Options.....	6
Color Options.....	9
Painted Exterior.....	10
Hardware Finishes.....	12
Glass Packages.....	14
Privacy and Tint Glass Options.....	15
Grid Options.....	16
Internal Blinds.....	17
Inspirations™ Art Glass.....	19
ProVia App & Visualizer.....	20





WHY CHOOSE WOOD-CLAD VINYL

YOUR VERSATILE PATIO DOOR SOLUTION

Aeris™ patio doors are constructed of an exclusive PVC formula, consisting of a unique mixture of resin and additives. A vinyl exterior ensures long-lasting color retention and low maintenance, plus the added confidence of a warranty against rotting, cracking, pitting, corroding and peeling. The PVC formula gives the Aeris patio door a very durable and rigid frame. With that, you'll also get a factory-finished real wood interior, stained or painted to the color of your choice. The Aeris patio door is truly a unique product, offering both vinyl and wood to suit your needs.

Customize your patio door by choosing the size, number of panels, interior and exterior colors, hardware finish and glass package. The design options are virtually endless!

WHAT TO EXPECT WITH YOUR AERIS PATIO DOOR

Pre-Finished Real Oak, Cherry or Maple Wood Applied to Sash and Frame Interior

Galvanized Steel Reinforced Panels and Sill

Patented Water Drainage System

Multi-Chamber Profiles with Neopor® Insulation

Aluminum Screen Frame with BetterVue® Fiberglass Mesh

Patented Sliding System with 4 Adjustable 1" Wheels per Panel

Spring-Loaded Latch System Automatically Engages Upon Closing

Proprietary AccuVent™ Allows Multiple Venting Options

Perfectly Interlocking Fixed and Mobile Panel Rails

A PATIO DOOR TO FIT YOUR HOME

Two, Three or Four Panel Options

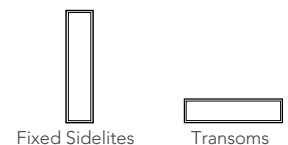
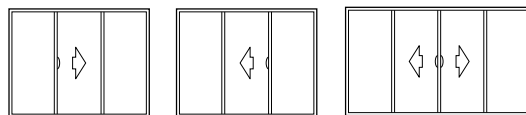
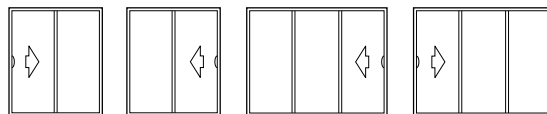

LIFETIME
— LIMITED WARRANTY —

UNDERSTANDING YOUR PATIO DOOR FEATURES

VENTING

AccuVent™

AccuVent is ProVia's proprietary design featuring a two-part interconnecting system at the sash rail and a ratcheting option at the top of the patio frame giving you multiple venting options. This will be standard on your Aeris™ patio door.



Available in White, Beige, Sandstone and Bronze.



Sash Latch cover available in White, Beige, Sandstone and Bronze. Sash latch is available in black only.



AccuVent is not available for wind load or coastal impact rated patio doors.

INSULATION

Neopor®

Neopor is a graphite polystyrene rigid foam insulation that gives maximum efficiency and sustainability in building products. It is comprised of many small pockets of air within a polymer matrix containing graphite. The graphite reflects radiant heat energy like a mirror, increasing the material's resistance to the flow of heat, or R-value. Most polymer-based foams exhibit a greater ability to slow the movement of heat as the temperature decreases; however, Neopor is unique because it increases R-Value as the temperature outside drops.



The vinyl profiles used in an Aeris™ patio door are designed with premium wall cavities providing the highest levels of efficiency. This strong and rigid vinyl extrusion keeps you comfortable in your home without the need for insulation.

To provide further comfort, ProVia® uses Neopor insulation in certain cavities for even greater performance. Therefore, you can rest assured both the patio door frame and sash, along with the Neopor insulation are effectively regulating the temperature inside your home.

WEATHERSTRIPPING

Weatherstripping is a very important part of preventing air from coming into your home. ProVia's patio doors have weatherstripping on the frame and sash, ensuring you get a good seal at the important locations where air could pass through.

Bulb Seal

Bulb seals are seamless closed-cell compression seals that prevent water from penetrating the foam cell structure. Its extruded skin provides a unique UV resistant barrier with design features that enhance the weatherstrip's sealing performance.

Barrier-Fin

Seal woven and extruded pile weatherstripping with fin provides a very effective barrier against air, water, dust and noise, sealing against even and uneven surfaces with resistance to abrasion.

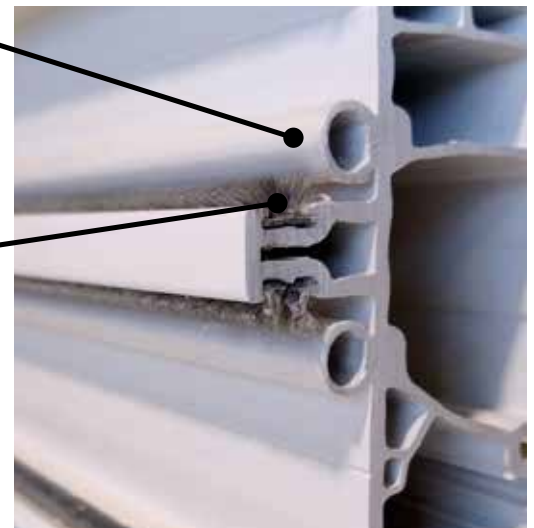

TEST SPECIFICATIONS

Aeris Patio Door 71" x 82"

Test	Test Specification	Results
Air	AAMA/WDMA/CSA 101/I.S.2/A440-08 par. 5.3.2.2 & ASTM-E283-04	0.03 cfm/ft ² @ 25 mph
Water	AAMA/WDMA/CSA 101/I.S.2/A440-08 par. 5.3.3.2 & ASTM-E547-00 (2009)	9.00 psf
Structural	AAMA/WDMA/CSA 101/I.S.2/A440-08 par. 5.3.4.3 & ASTM-E330-02 (2010)	DP60 155 mph

YOUR SCREEN OPTIONS

STANDARD

BetterVue® Fiberglass

Your Aeris™ patio door will come standard with a top-hung aluminum frame with BetterVue fiberglass mesh, which can be easily removed for regular cleaning and maintenance.

BetterVue screen mesh is very durable and flame retardant, providing an enhanced view, increased insect protection and improved airflow.

Now featuring Phifer's® Water Shed Technology™, which preserves optical clarity by shedding water and resisting dirt and grime.



The Water Shed Technology features a hydrophobic coating that will not wash off, which allows the screen to shed water and debris from a rainstorm or garden hose. This means your screen virtually eliminates window panning, a process by which the water fills the open squares in the screen.

SCREEN FEATURES



Spring-loaded latch system automatically engages upon closing with its interior locking feature. Picture shown with BetterVue® fiberglass mesh. Heavy-duty fiberglass, stainless steel or aluminum mesh is optional.

OTHER OPTIONS

SeeVue® Stainless Steel

Much stronger than the standard insect screen, this stainless steel screen is excellent for patio door applications. It is black coated for improved visibility and allows superior airflow.

If you're looking for a stronger alternative to the BetterVue screen, upgrade to a SeeVue.

Also available: Aluminum and Heavy Duty Fiberglass Screen Mesh



Suspended by ball bearing rollers, this top-hung heavy-duty aluminum screen frame reduces binding, creating effortless operation.

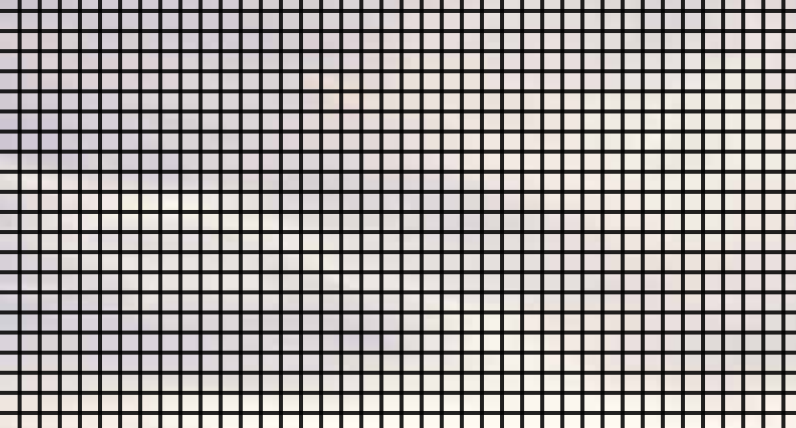

Industry Standard Insect Screen

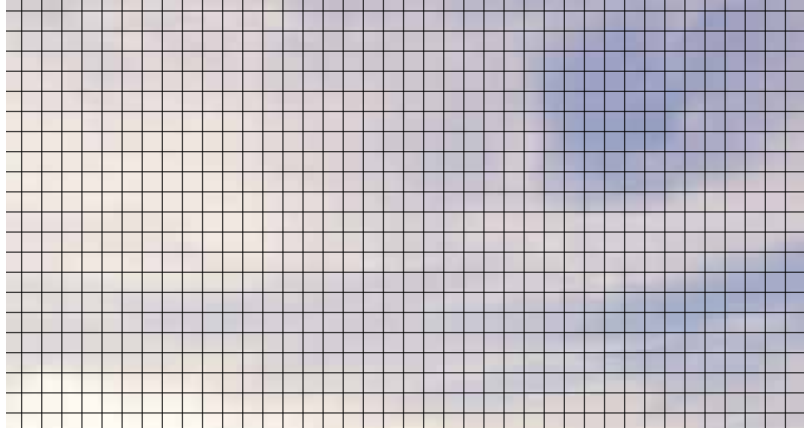

BetterVue® Screen





Shown: Truffle Stained Interior

CHOOSE YOUR COLORS

Aeris™ patio doors feature factory-finished real wood interiors. Due to the nature of hand-applied stain on wood, colors and grain patterns may vary slightly.

Exterior Vinyl and TUFTEX Smooth Cladding Colors

Cladding is aluminum trim coil with mar-resistant smooth finish



Classic Bronze is a laminated option on vinyl.

Interior Stain Finishes

Oak

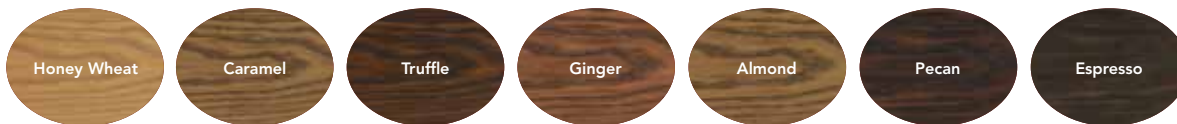

Cherry



Maple



Interior Paint Finishes

Maple



Always refer to our color selectors for accurate color representation. Jamb pocket color may be different than the interior paint or stain color. Custom interior paint and stain color matching is available.

UPGRADE TO A PAINTED EXTERIOR

Complement the exterior of your home with a painted patio door to give your house a distinctive look. Choose from one of ProVia's standard paint colors (below) or use your imagination and custom-match any color of your choice.

The factory-applied paint finish maintains long-lasting color due to its exceptional UV and heat reflective properties. Choosing to paint the exterior of your patio door means no worry of peeling, flaking, or blistering.

Paint finish will have a 15-year warranty. If you choose a painted exterior, allow for an additional lead time.

Exterior Paint Finish Options



Always refer to our color selector for accurate color representation.

See the Color Lookbook for more exterior paint color options.



Custom-Matched Paint Colors

How to Order Custom Painted Patio Doors

1. Visit a Sherwin Williams paint store and select a paint color of your choice.
2. Specify the selected color name and paint number from the paint color swatch at the time of order.

OR

1. Provide your dealer with three 3" x 3" samples of the selected color from any store for ProVia® to match.

Color match fee applies.





Shown: Coal Black Painted Exterior

SELECT YOUR HARDWARE FINISH

Aeris™ patio doors come standard with Multi-Point Mortise Lock hardware.

The Schlage® C Keyway on all keyed locking handles allow a single key entry for the entire house.

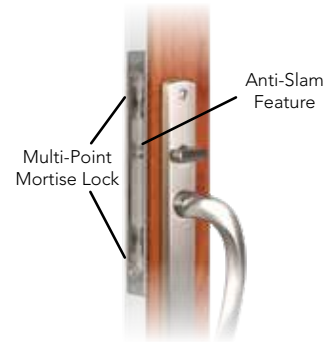

SIGNATURE HARDWARE

Standard Finishes
with Keylock



MODERN HARDWARE

with Keylock



Optional Finishes

with Keylock and without Keylock



Keyed hardware also available with White interior and Beige, Sandstone, Black or Bronze exterior.



Shown: Toffee Stained Interior with Aged Bronze Handle

WHICH GLASS PACKAGE IS RIGHT FOR YOU?

FEATURING COMFORTECH™ WARM EDGE GLAZING SYSTEM

Most of your new patio door is glass. That's why we use the ComforTech Warm Edge Glazing System featuring Super Spacer® on all Aeris™ patio doors. This gives you reduced heat loss, warmer glass temperature and reduced interior condensation. All ComforTech products have passed stringent testing and are IG Certified to ensure seals are durable and will not leak.



The No-Metal Advantage

Thermal efficiency through no presence of conductive metals is the Super Spacer hallmark.

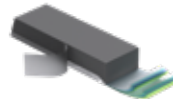

Mylar 10-Layer Vapor Barrier

The Super Spacer thermoset foam matrix helps keep moisture out, and gas in, making conductivity virtually nonexistent.



Lasting Appearance

Our Warm Edge Glazing System stands up to the natural bending and bowing from temperature changes, barometric pressure and wind load.



Enhanced Noise Reduction

The all-foam formula's excellent sound dampening properties reduce outside noise, even in industrial environments.

WHAT'S THE DIFFERENCE?

Krypton Gas

Inert to glass coatings, heat and spacers, krypton gas has the lowest conductivity of any gas used and raises the inner glazing temperature. This gas performs well in small chambers, making it the best choice for triple-glazed glass packages.

Argon Gas

Chemically inert to UV radiation, argon gas insulates better than air. It is sunlight stable, non-corrosive and non-toxic, making it the best choice for double-glazed glass packages.

ComforTech™ TLK-UV

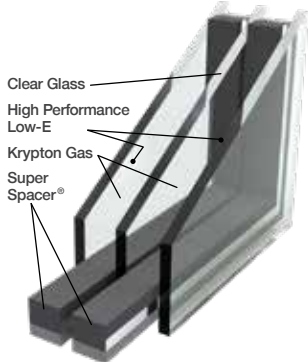

R-Value of 9

ComforTech™ TLA-UV

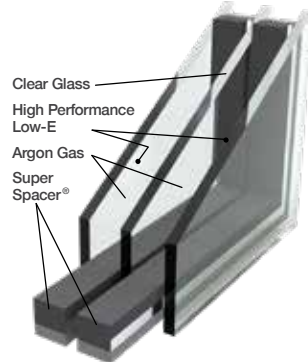

R-Value of 6

ComforTech™ DLA-UV-HC



R-Value of 5

ComforTech™ DLA-UV

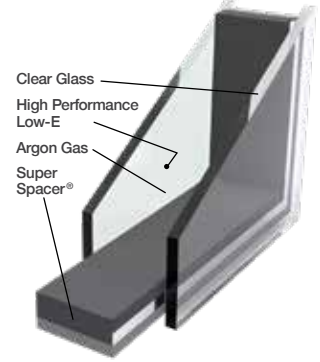

R-Value of 4

ADD EXTRA PRIVACY AND TINT TO YOUR PATIO DOOR

Privacy Options

Choose from five different types of glass if you need light to filter in, yet want to maintain privacy. These glass styles look great in rooms where privacy is important. Regardless of where it is used, privacy glass reduces the likelihood of needing extra patio door coverings.



CHINCHILLA



TAFFETA



WATERFALL



GLUECHIP



OBSCURE PEBBLE

Actual privacy levels will vary depending on your distance from the glass and also the amount of light in the room in comparison to the light outside your home. For extra privacy, choose two panes of privacy glass, rather than just one.

Tint Options

Tinted glass can help reduce UV transmittance, solar heat gain and glare. Tinted glass options can give a room a whole new look, providing its own unique set of benefits. Be sure to choose the right one for you.



Gray

- Excellent glare control
- Exceptional protection against interior fabric and color fading
- Ultraviolet light protection



Bronze

- High visible light transmittance
- Warm glow to interior décors
- Complements brick and stone
- Ultraviolet light protection



Green

- Subdues interior brightness
- High visible light transmittance



Blue

- Low shading coefficient
- High visible light transmittance
- Solar performance (reduces solar heat gain)

STYLE YOUR PATIO DOOR WITH GRIDS

The style of grids you choose can make a big impact on your home's appearance. You can choose from several internal grid patterns including variations of Cottage, Colonial and Prairie styles.



Contoured



Flat



V-Groove



Cottage



Colonial



Prairie



Triple Glazed Glass

Internal grids with triple glazed glass are placed between two glass panes with the added efficiency of a third pane.



Double Glazed Glass

Internal grids with double glazed glass are placed between two panes of glass.

ADD INTERNAL BLINDS

If cleaning dusty blinds makes you cringe, be sure to add internal blinds to your patio door. These blinds are made with sturdy aluminum and are custom-fit to the exact dimensions of each patio door.

Internal blinds can be lifted up, or simply tilted, depending on your lighting and privacy needs.



Exterior View



Interior View of Blinds with Operator



White internal blinds will have two operators (as shown above). Colored internal blinds will have one operator that lifts and tilts (as shown to the left).

Internal blinds come with a **10-year Limited Warranty**.

Blind slats are ½" wide.

Allow for additional lead time on your patio door order.

Not available in 50" x 80" or 96" x 80" sizes.

Blinds and grids not available together.



Blinds with Low-E on surfaces 2 and 4 are ENERGY STAR® Certified nationwide.

Complement the interior of your home with one of five colors:





Americana with Vineyard Color Palette



Blossoms with Caribbean Color Palette

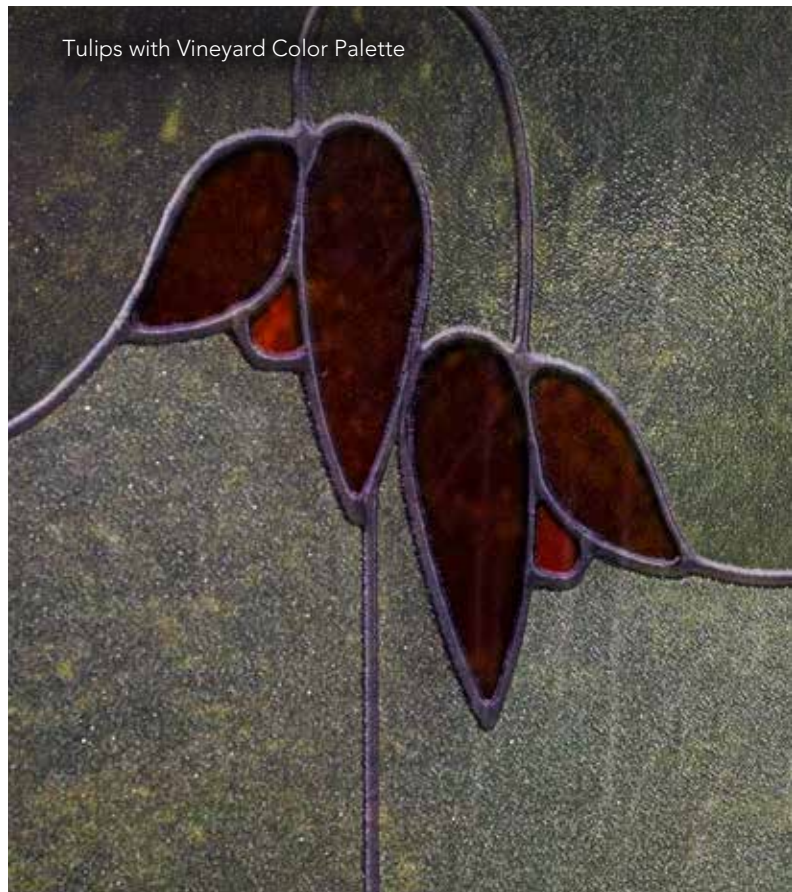

Tulips with Vineyard Color Palette

IMAGINE THE POSSIBILITIES

WITH INSPIRATIONS™ ART GLASS

Inspirations Art Glass allows you to do just what the name suggests, let your patio door reflect the inspiration of your imagination with your choice of design and color.



Explore Design and Color Options

Ask to see our Inspirations Art Glass brochure for available styles and color palettes, visit provia.com or use the ProVia iPad app to create custom color palettes and design your dream patio door.



Color Palettes

The greatest advantage of Inspirations Art Glass is the opportunity you have to add color to your glass. There are a variety of unique color palettes to suit your home's style.

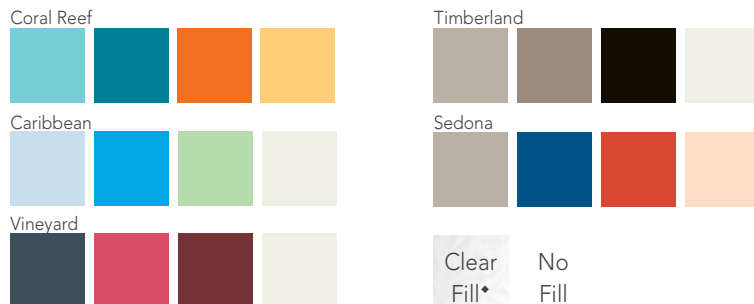

* Increases transparency on textured glass and resembles aged glass

Resin Beads

Available in four color options.



Combine your favorite color palette and bead color with your choice of design to show your personality on your patio door.

All Inspirations Art Glass requires additional lead time.



SHOW US YOUR STYLE AND CONNECT WITH US!

We love seeing how you apply our products to your home. Share photos with us.



CREATE YOUR DREAM HOME

WITH PROVIA'S EXTERIOR HOME DESIGN TOOLS

Find inspiration for the exterior of your home.
Download ProVia's free app for iPad or try the online Visualizer at provia.com/visualizer.



PROVIA VISUALIZER

Use ProVia's Visualizer to change the colors and styles of your home's doors, windows, siding, stone and roofing.

Let your imagination run free with this exterior home design tool. Select from a library of existing home styles, choosing one to match yours, or upload a photo of your own home.

In a few easy steps, update your siding color, add manufactured stone or a metal roof, give the windows a fresh look or personalize a new entry door.

Not sure where to start? Apply one of our pre-selected Designer Collections, then further customize the selections to reflect your own personal style.



PROVIA APP

Use the ProVia app to configure doors and windows or select from an extensive collection of vinyl siding, manufactured stone and metal roofing styles.

FEATURES

Door and Window Configurator

Vinyl Siding Profiles, Colors and Accessory Accents

Manufactured Stone Styles, Color Palettes and Grout Options

Metal Roofing Styles, Colors and Trim Accents

View Videos, Photo Galleries and Catalogs

Locate a ProVia Dealer





“To serve, by caring for details in ways others won’t.” It’s not just our mission, but a way of letting our light shine every day at ProVia®. We continually strive to put these words into action by providing unmatched quality and service. The P-icon symbolizes each employee’s commitment to devoting the utmost care, pride and quality into each building product we manufacture...it’s The Professional Way.



At ProVia, we manufacture energy efficient products and exercise corporate environmental stewardship by recycling, reducing pollution emissions and much more. In fact, our company has received repeated awards from the Environmental Protection Agency such as Partner of the Year - Sustained Excellence for outstanding efforts in energy savings.

Distributed by:



DOORS | WINDOWS
SIDING | STONE | ROOFING

provia.com

© 2020 ProVia
P-MK-02550-20 | 11/20