

METAL ROOFING
PRODUCT SPECIFICATIONS



METAL ROOFING

— PRODUCT SPECIFICATIONS —

Table of Contents

Shake and Slate

Panels	2-3
Starter Panels.....	4
Ridge/Hip Caps	5

Trims and Flashings

Color Codes.....	6-7
Eave Starters	8
Rakes.....	8
Sidewall	9
Apron.....	9
Valley.....	9
Anchor Cleat.....	10
Underpans.....	10
Ridge/Hip Bases.....	11
Ridge Vent.....	11

Accessories

Trim Coil	12
Pipe Flashing	12
Snow Diverters.....	12
Underlayments.....	13
Sealant.....	13
Touch-Up	13
Fasteners (Screws, Nails, Pop Rivets).....	14

Shipping Guide.....	15
---------------------	----

Standards and Certifications	16
------------------------------------	----



Ironstone Slate
On Cover: Baystone Slate

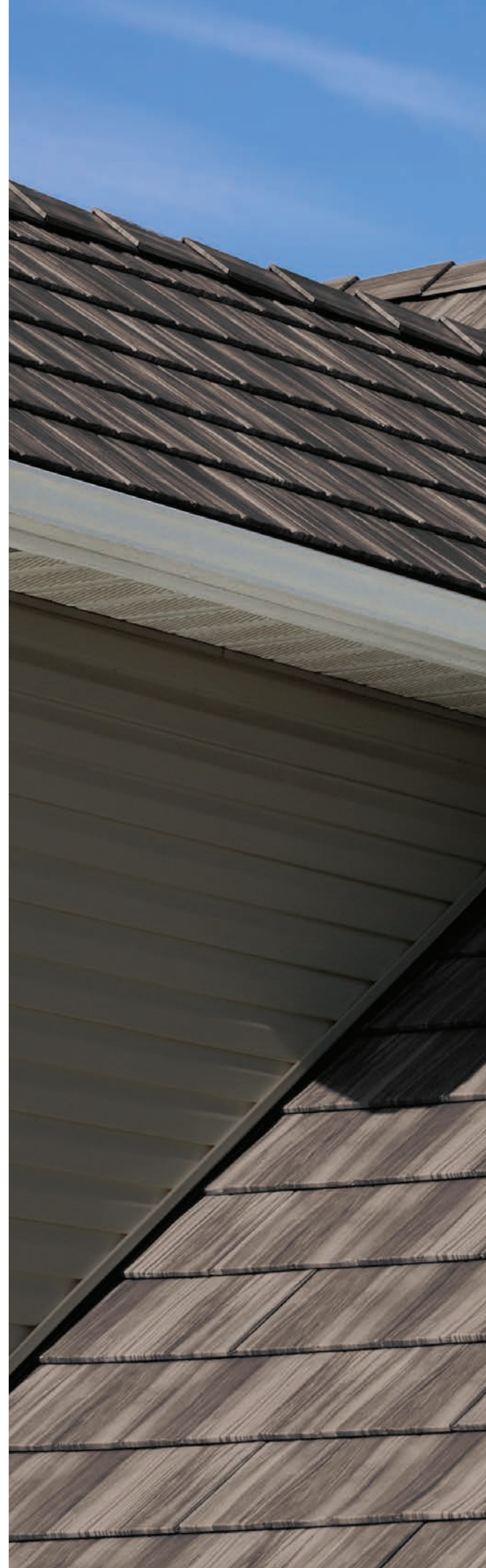



Briarwood Shake

METAL ROOFING SHAKE PANELS

SHAKE

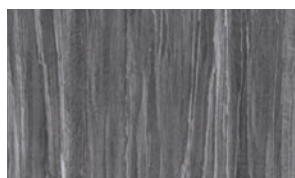
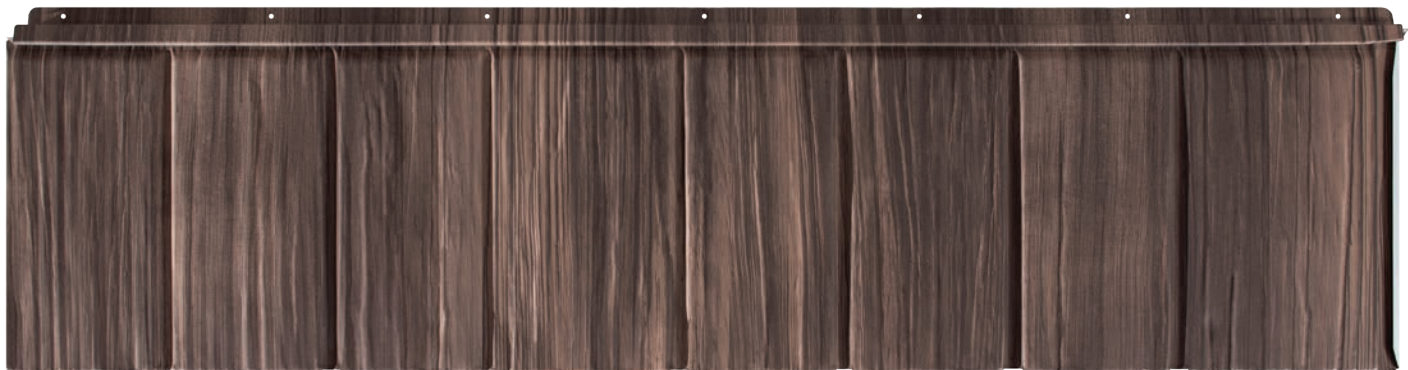

Shadewood
R-PN-5000-P108

Coordinating Trims;
Shade Solid & Decorative



Pepperwood
R-PN-5000-P110

Coordinating Trims;
Pepper/Iron Solid & Decorative

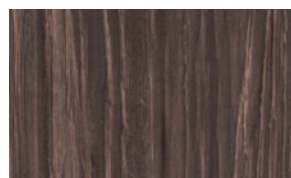

Saddlewood
R-PN-5000-P130

Coordinating Trims;
Saddle Solid & Decorative

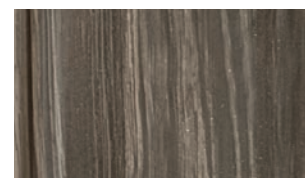

Briarwood
R-PN-5000-P131

Coordinating Trims;
Briar/Lodge Solid &
Briar Decorative

Panel Dimensions: 50¹/₂" x 13⁷/₈" (50" x 12" Exposure)
 Panel Weight: 4lbs 7oz
 Pieces Per Box: 12
 Box Weight: 56lbs
 Box Dimensions: 53" x 15" x 5⁵/₁₆"

**Product Test Standards
& Certifications**
 Refer to page 16

See page 15 for additional packaging and shipping information.

METAL ROOFING SLATE PANELS

SLATE

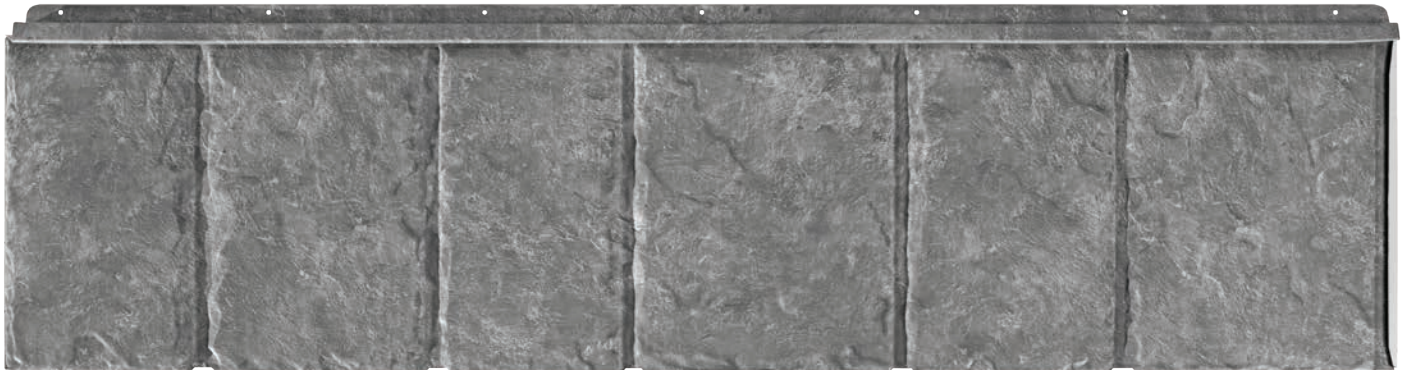

Baystone
R-PN-5010-P051

Coordinating Trims;
Bay Solid & Decorative

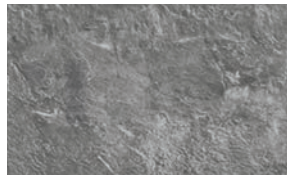

Ironstone
R-PN-5010-P112

Coordinating Trims;
Pepper/Iron Solid & Decorative



Larkstone
R-PN-5010-P137

Coordinating Trims;
Lark Solid & Decorative

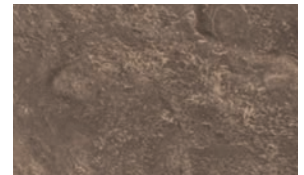

Lodgestone
R-PN-5010-P138

Coordinating Trims;
Briar/Lodge Solid &
Lodge Decorative

Panel Dimensions: 50¹/₂" x 13⁷/₈" (50" x 12" Exposure)
 Panel Weight: 4lbs 6oz
 Pieces Per Box: 12
 Box Weight: 55lbs
 Box Dimensions: 53" x 15" x 5⁵/₁₆"

**Product Test Standards
& Certifications**
 Refer to page 16

See page 15 for additional packaging and shipping information.

METAL ROOFING STARTER PANELS

When ordering, replace "???" with the appropriate color code to complete the part number.

SHAKE STARTER PANELS

Box Part No.: R-PN-3000-????
Per Box: 21 Pieces (3 Full Sets of Starters and 9 Stoppers)
Box Weight: 55lbs
Box Dimensions: 52½" x 18" x 5½"

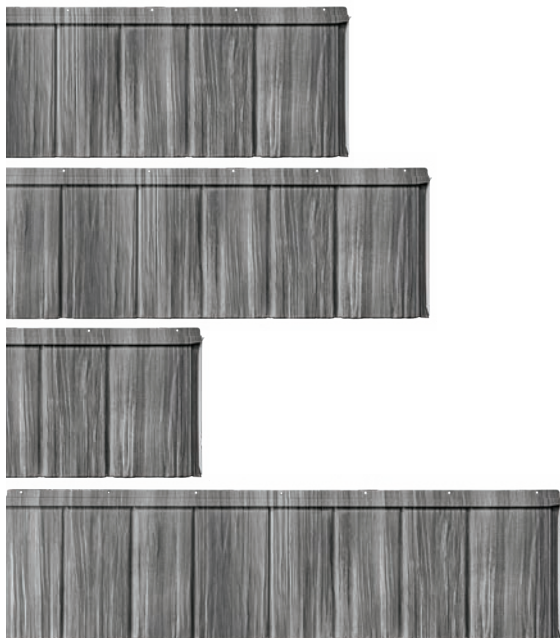

Recommended Sequence For Starter Panel Installation.



Shadewood
P108



Pepperwood
P110



Saddlewood
P130

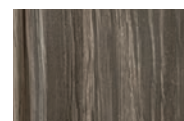

Briarwood
P131

SLATE STARTER PANELS

Box Part No.: R-PN-3001-????
Per Box: 21 Pieces (3 Full Sets of Starters and 9 Stoppers)
Box Weight: 54lbs
Box Dimensions: 52½" x 18" x 5½"



Recommended Sequence For Starter Panel Installation.



Baystone
P051



Ironstone
P112

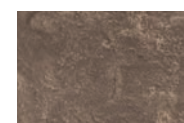

Lodgestone
P138



Larkstone
P137

See page 15 for additional packaging and shipping information.

METAL ROOFING RIDGE CAPS

When ordering, replace "?????" with the appropriate color code to complete the part number.

SHAKE RIDGE/HIP CAP

Box Part No.: R-TR-6000-????
Piece Part No.: R-TR-P6000-????
Pieces Per Box: 20
Part Dimensions: 14" x 11³/₄" x 3¹/₂"

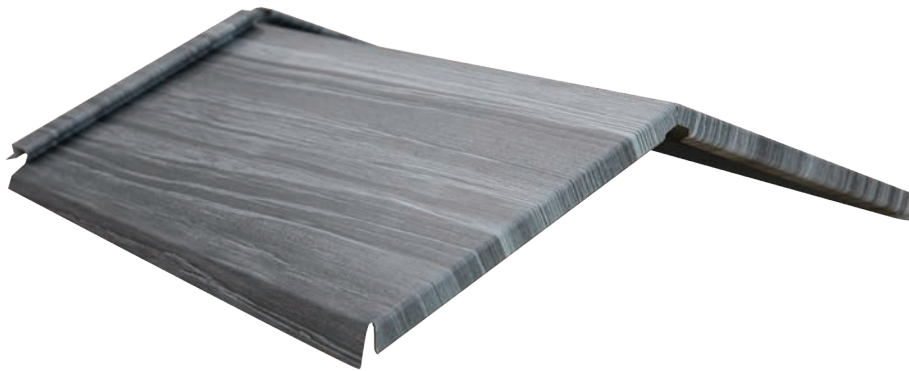

Shadewood
P108



Pepperwood
P110

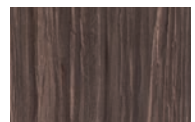

Saddlewood
P130



Briarwood
P131

SLATE RIDGE/HIP CAP

Box Part No.: R-TR-6000-????
Piece Part No.: R-TR-P6000-????
Pieces Per Box: 20
Part Dimensions: 14" x 11³/₄" x 3¹/₂"



Baystone
P051

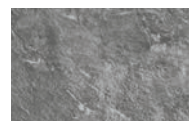

Ironstone
P112

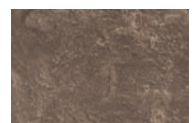

Lodgestone
P138



Larkstone
P137

METAL ROOFING TRIMS AND FLASHINGS

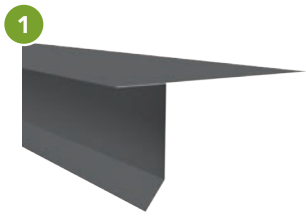

1
Eave Starter

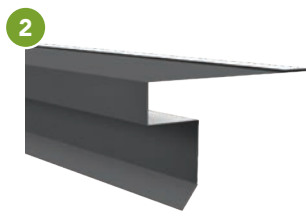

2
RetroFit™ Eave Starter



3
Rake

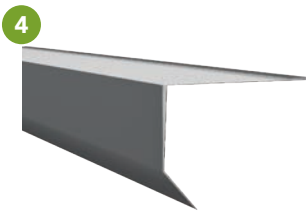

4
RetroFit™ Rake



5
Sidewall



6
Valley

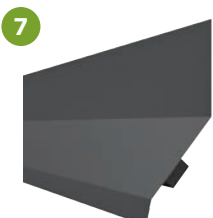

7
Apron

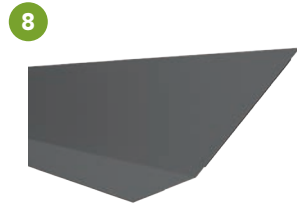

8
Anchor Cleat*



9
6" Underpan*



10
20" Underpan*
Used for vent pipes, bathroom vents, etc.
Not shown on illustration.



11
Ridge/Hip Base*
For Non-Vented Installations

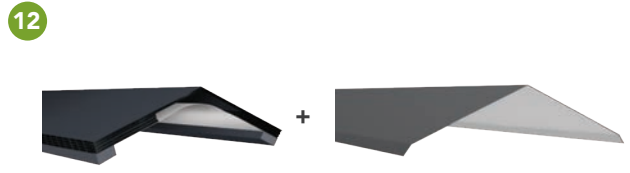

12
Quarrix Ridge Vent with Ridge Base*
For Vented Installations



METAL ROOFING TRIM COLOR CODES

SOLID COLORS



Bay
4078



Shade
4080



Pepper/Iron
4079



Saddle
2772



Briar/Lodge
2771



Lark
2773

* Unexposed components are Pepper/Iron Solid 4079.

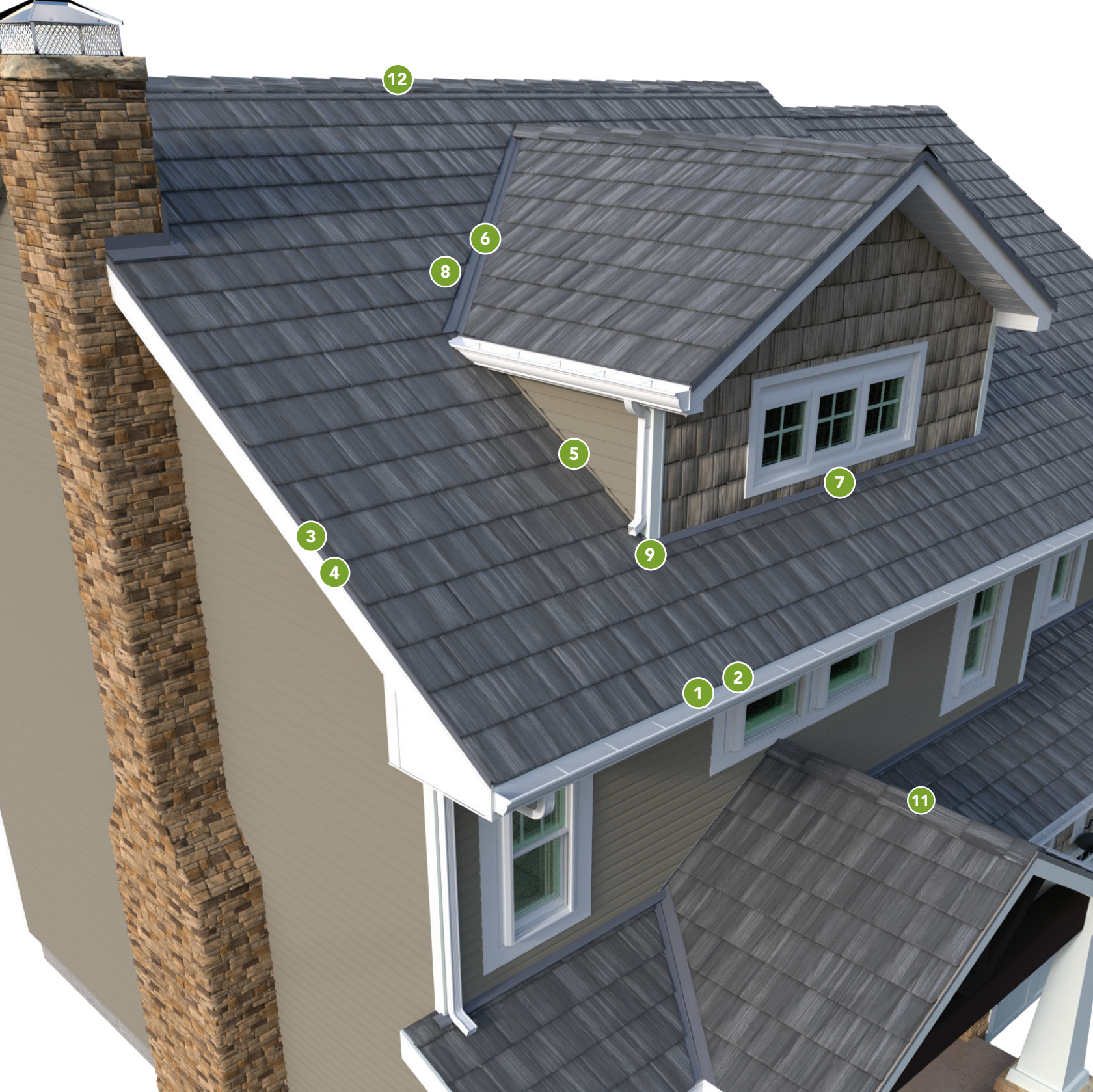

DECORATIVE COLORS



Bay
T051

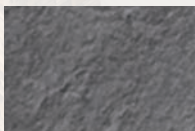

Shade
T108

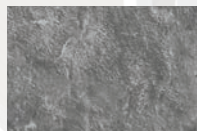

Pepper/Iron
T111

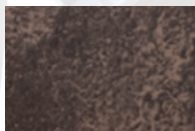

Saddle
T130

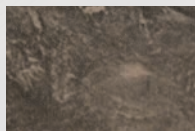

Briar
T131

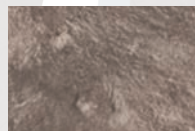

Lark
T137

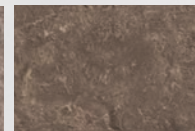

Lodge
T138

METAL ROOFING TRIMS AND FLASHINGS

When ordering, replace "???" with the appropriate color code listed on pages 6 & 7 to complete the part number.

EAVE STARTER

Box Part No.: R-TR-6015-???
 Piece Part No.: R-TR-P6015-???
 Pieces Per Box: 10
 Part Length: 10'

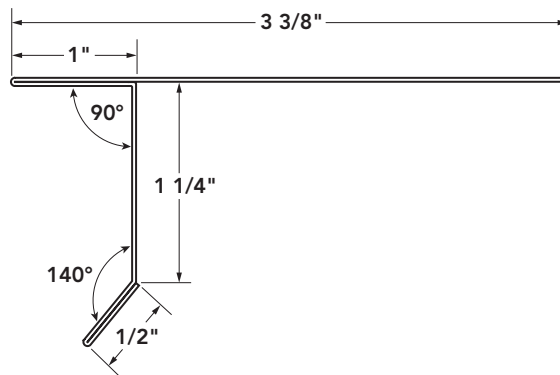
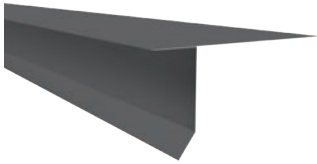

RETROFIT™ EAVE STARTER

Box Part No.: R-TR-6045-???
 Piece Part No.: R-TR-P6045-???
 Pieces Per Box: 10
 Part Length: 10'

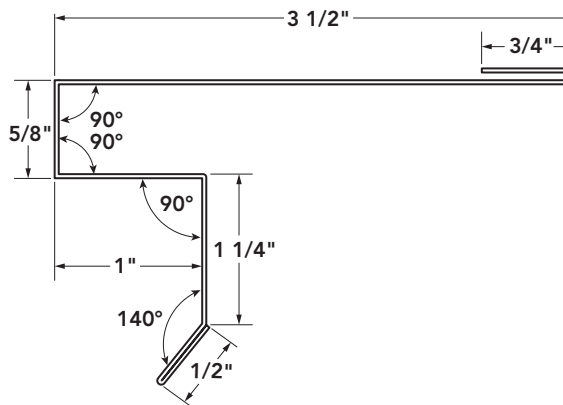
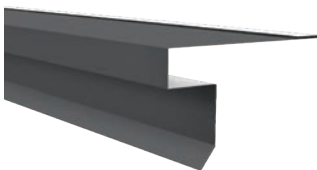

RAKE

Box Part No.: R-TR-6020-???
 Piece Part No.: R-TR-P6020-???
 Pieces Per Box: 10
 Part Length: 10'

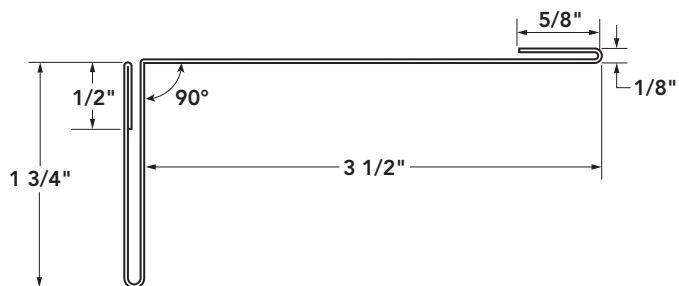

RETROFIT™ RAKE

Box Part No.: R-TR-6050-???
 Piece Part No.: R-TR-P6050-???
 Pieces Per Box: 10
 Part Length: 10'

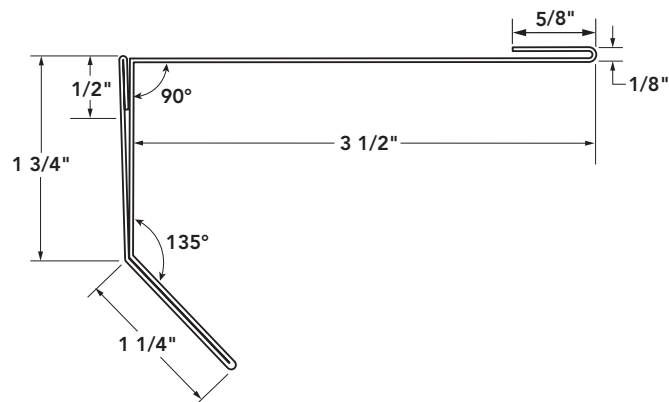

See page 15 for additional packaging and shipping information.

METAL ROOFING TRIMS AND FLASHINGS

When ordering, replace "?????" with the appropriate color code listed on pages 6 & 7 to complete the part number.

SIDEWALL

Box Part No.: R-TR-6030-????
 Piece Part No.: R-TR-P6030-????
 Pieces Per Box: 5
 Part Length: 10'

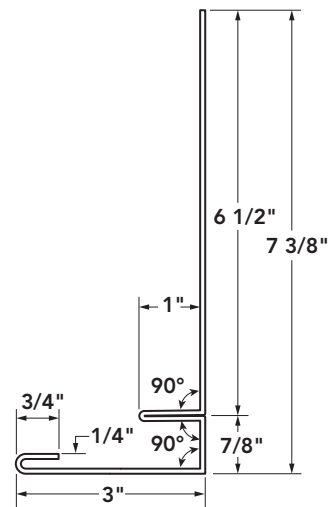

APRON

Box Part No.: R-TR-6035-????
 Piece Part No.: R-TR-P6035-????
 Pieces Per Box: 5
 Part Length: 10'

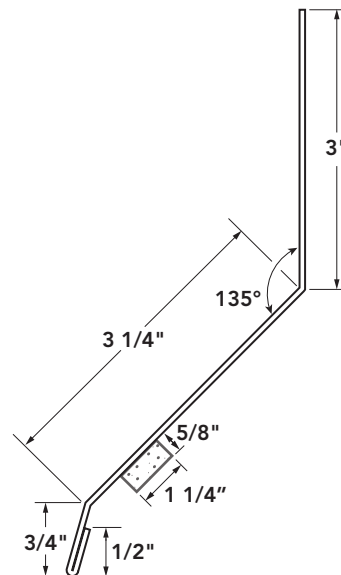
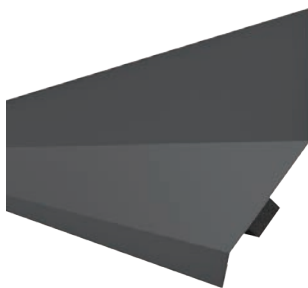

VALLEY

Box Part No.: R-TR-6025-????
 Piece Part No.: R-TR-P6025-????
 Pieces Per Box: 5
 Part Length: 10'

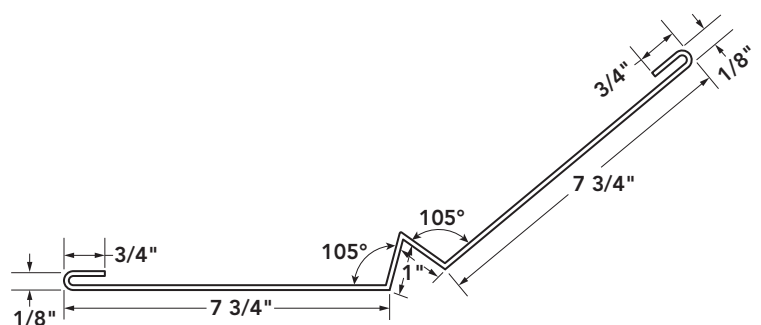

See page 15 for additional packaging and shipping information.

METAL ROOFING TRIMS AND FLASHINGS

ANCHOR CLEAT

Part Not Seen Once Installed. Available In Pepper/Iron 4079.

Box Part No.: R-TR-6055
 Piece Part No.: R-TR-P6055
 Pieces Per Box: 10
 Part Length: 10'

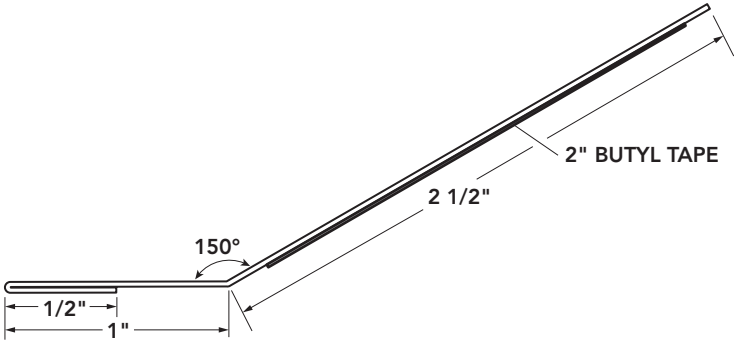
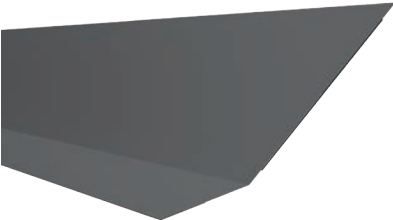

6" UNDERPAN

Part Not Seen Once Installed. Available In Pepper/Iron 4079.

Box Part No.: R-TR-6075
 Piece Part No.: R-TR-P6075
 Pieces Per Box: 10
 Part Length: 1'4"

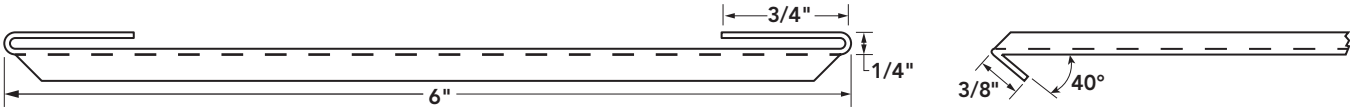

20" UNDERPAN

Part Not Seen Once Installed. Available In Pepper/Iron 4079.

Box Part No.: R-TR-6070
 Piece Part No.: R-TR-P6070
 Pieces Per Box: 10
 Part Length: 1'8"

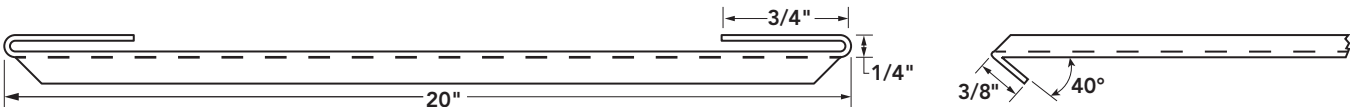

See page 15 for additional packaging and shipping information.

METAL ROOFING TRIMS AND FLASHINGS

RIDGE BASE

Part Not Seen Once Installed. Available In Pepper/Iron 4079.

Box Part No.: R-TR-6065
 Piece Part No.: R-TR-P6065
 Pieces Per Box: 5
 Part Length: 10'

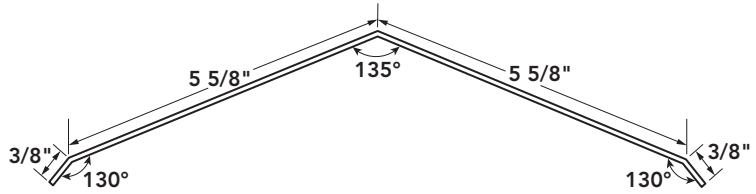
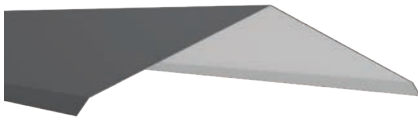

RIDGE/HIP BASE

For Non-Vented Installations.
 Part Not Seen Once Installed. Available In Pepper/Iron 4079.

Box Part No.: R-TR-6060
 Piece Part No.: R-TR-P6060
 Pieces Per Box: 5
 Part Length: 10'

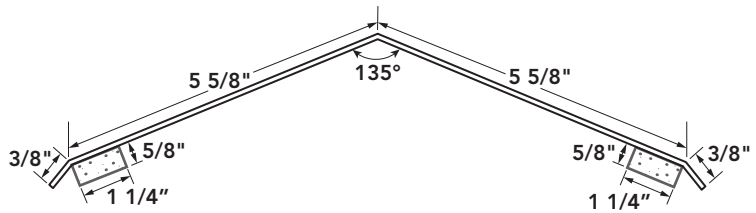

QUARRIX® RIDGE VENT

Box Part No.: R-AC-7000
 Piece Part No.: R-AC-P7000
 Pieces Per Box: 5
 Part Length: 10'

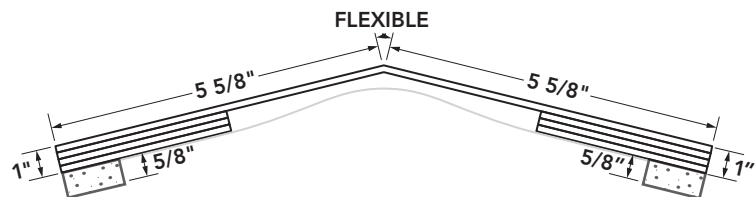
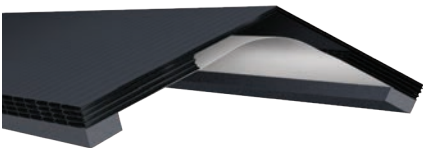

See page 15 for additional packaging and shipping information.

METAL ROOFING ACCESSORIES

When ordering, replace "???" with the appropriate color code listed on pages 6 & 7 to complete the part number.

TRIM COIL

Part No.: R-TR-6040-???

Pieces Per Box: 1

Part Size: 30' x 16"

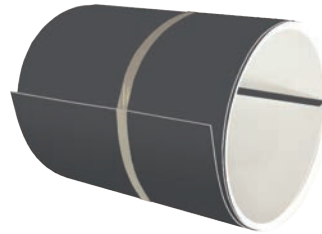

ULTIMATE® PIPE FLASHING

Part No.: R-AC-7025

Size: 1 1/2"

Pieces Per Box: 1

Part No.: R-AC-7035

Size: 3"

Pieces Per Box: 1

Part No.: R-AC-7030

Size: 2"

Pieces Per Box: 1

Part No.: R-AC-7040

Size: 4"

Pieces Per Box: 1



BATH/DRYER VENT

Part No.: R-AC-7043

Size: 17.53" x 15.38" x 5.81" (Size does not include Steel Connector)

Pieces Per Box: 1



PROGRIP™ SNOW DIVERTER

ProVia Exclusive – form-fit, concealed fastener.
For use in initial roof application.

COMING SOON - CALL FOR AVAILABILITY

Part No.: R-AC-7010-???

Order By The Piece



STANDARD SNOW DIVERTER

For retrofitting, post roof application.

Box Part No.: R-AC-7015-???

Order By The Piece

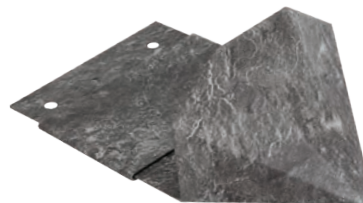

See page 15 for additional packaging and shipping information.

METAL ROOFING ACCESSORIES

SHARKSKIN® ULTRA SA

Part No.: R-AC-7006
Pieces Per Box: 1 Roll
Part Length: 48" x 125'
(5 Square Roll)
(Net Coverage: 470 Sq. Ft.)



SHARKSKIN® ULTRA

Part No.: R-AC-7005
Pieces Per Box: 1 Roll
Part Length: 48" x 250'
(10 Square Roll)
(Net Coverage: 960 Sq. Ft.)



FIRESTONE CLAD-GARD™ SA-FR

Part No.: R-AC-7004
Pieces Per Box: 1 Roll
Part Length: 39" x 67'
(2 Square Roll)
(Net Coverage: 200 Sq. Ft.)



When ordering, replace "???" with the appropriate color code listed on pages 6 to complete the part number.

SOUDAL® SEALANT

Part No.: R-AC-7020-???

Size: 10.1 oz.

Available in Solid Colors - See Pg. 6



TOUCH-UP PAINT PEN

Part No.: R-AC-7045-???

Size: .5 oz.

Available in Solid Colors - See Pg. 6



See page 15 for additional packaging and shipping information.

METAL ROOFING ACCESSORIES

FASTENERS



#10 x 1" Hex Head Panel Screw - 31lb Box
Part No.: R-AC-7050
Pieces: 5000

5lb Box
Part No.: R-AC-7051
Pieces: 800



#10 x 1 1/2" Hex Head Panel Screw - 25lb Box
Part No.: R-AC-7052
Pieces: 3000

5lb Box
Part No.: R-AC-7053
Pieces: 500



#10 x 2" Hex Head Ridge/Hip Screw - 27lb Box
Part No.: R-AC-7055
Pieces: 2500

5lb Box
Part No.: R-AC-7056
Pieces: 450



#10 x 1" Pancake Head Screw - 5lb Box
Part No.: R-AC-7061
Pieces: 700

12oz Box
Part No.: R-AC-7060
Pieces: 100



#10 x 1" Hex Head Sealing Washer Screw - 31lb Box
Part No.: R-AC-7070
Pieces: 3000

5lb Box
Part No.: R-AC-7071
Pieces: 610



#10 x 1 1/2" Hex Head Sealing Washer Screw - 5lb Box
Part No.: R-AC-7072
Pieces: 400



1" Plastic Cap Nail - 6lb Box
Part No.: R-AC-7065
Pieces: 2000



2" Pop Rivet
Part No.: R-AC-7075-????
Pieces: 20
Available in Solid Colors - See Pg. 6

When ordering, replace "???" with the appropriate color code listed on pages 6 to complete the part number.

See page 15 for additional packaging and shipping information.

PRODUCT SHIPPING GUIDE

PART #	PRODUCT DESCRIPTION	BOX DIMENSIONS				PALLET		
		L	W	H	WEIGHT (#)	BOXES	TYPE	WEIGHT
R-PN-5000-????	SHAKE PANEL	53	15	5.75	55.70	30 (15 SQ)	A	1670
R-PN-5010-????	SLATE PANEL	53	15	5.75	54.58	30 (15 SQ)	A	1637
R-PN-3000-????	SHAKE STARTER PANEL	52.50	18	5.50	54.53	20	A	1090
R-PN-3001-????	SLATE STARTER PANEL	52.50	18	5.50	53.60	20	A	1072
R-TR-6000-????	SHAKE RIDGE/HIP CAP	16.62	13.12	9.75	24	44	A	1150
R-TR-6000-????	SLATE RIDGE/HIP CAP	16.62	13.12	9.75	24	44	A	1150
R-TR-6015-????	EAVE STARTER	123.37	8.06	2.37	35.4	55	B	2027
R-TR-6045-????	RETROFIT EAVE STARTER	123.37	9.06	3.12	44	36	B	1664
R-TR-6020-????	RAKE	123.37	4.81	2.87	43.6	45	B	2042
R-TR-6050-????	RETROFIT RAKE	123.37	4.81	3.62	54	36	B	2024
R-TR-6030-????	SIDEWALL	123.37	9.18	3.37	36.05	32	B	1233.6
R-TR-6035-????	APRON	123.37	7.31	3.12	25	45	B	1205
R-TR-6025-????	VALLEY FLASHING	121.75	16.93	3.37	52.1	16	B	913.6
R-TR-6055	ANCHOR CLEAT	123.37	2.93	1.50	25.1	84	B	2188.4
R-TR-6075	6" UNDERPAN	16.50	6.37	4.75	6.2	126	A	833
R-TR-6070	20" UNDERPAN	20.50	20.37	4.75	20	24	A	532
R-TR-6065	RIDGE BASE	121.75	11.56	2.87	34.2	30	B	1106
R-TR-6060	RIDGE/HIP BASE	121.75	11.56	5.43	38.15	15	B	652.25
R-AC-7000	RIDGE VENT	121.75	12	6.75	26	14	B	444
R-TR-6040-????	TRIM COIL	12.25	12.25	16.50	27	36	A	1021
R-AC-7025	1.5" ULTIMATE PIPE FLASHING	19	14.25	3.25	-	-	-	-
R-AC-7030	2" ULTIMATE PIPE FLASHING	19	14.25	3.25	-	-	-	-
R-AC-7035	3" ULTIMATE PIPE FLASHING	21	16.25	6.50	-	-	-	-
R-AC-7040	4" ULTIMATE PIPE FLASHING	21	16.25	6.50	-	-	-	-
R-AC-7010-????	PROGRIP SNOW DIVERTER	25.50	8.50	15.50	-	-	-	-
R-AC-7015-????	STANDARD SNOW DIVERTER	25.50	8.50	15.50	-	-	-	-
R-AC-7004	FIRESTONE CLAD-GARD SA-FR	8.25	8.25	40	-	-	-	-
R-AC-7005	SHARKSKIN ULTRA UNDERLAYMENT	48.00	7.25	7.25	-	-	-	-
R-AC-7006	SHARKSKIN ULTRA SA ICE & WATER SHIELD	49.25	8.25	8.25	-	-	-	-
R-AC-7020-????	SOUDAL SEALANT	8	6	10	-	-	-	-
R-AC-7045-????	TOUCH-UP PAINT PEN	-	-	-	-	-	-	-
R-AC-7050	#10 X 1" HEX HEAD PANEL SCREW - 5000 PIECES	10.25	10.25	6	31	-	-	-
R-AC-7051	#10 X 1" HEX HEAD PANEL SCREW - 800 PIECES	4.25	3	6.50	5	-	-	-
R-AC-7052	#10 X 1.5" HEX HEAD PANEL SCREW - 3000 PIECES	-	-	-	25	-	-	-
R-AC-7053	#10 X 1.5" HEX HEAD PANEL SCREW - 500 PIECES	-	-	-	5	-	-	-
R-AC-7055	#10 X 2" HEX HEAD RIDGE/HIP SCREW - 2500 PIECES	10.25	10.25	6	27	-	-	-
R-AC-7056	#10 X 2" HEX HEAD RIDGE/HIP SCREW - 450 PIECES	4.25	3	6.50	5	-	-	-
R-AC-7060	#10 X 1" PANCAKE HEAD SCREW - 100 PIECES	10.25	10.25	6	12oz	-	-	-
R-AC-7061	#10 X 1" PANCAKE HEAD SCREW - 700 PIECES	4.25	3	6.50	5	-	-	-
R-AC-7065	1" PLASTIC CAP NAIL - 2000 PIECES	-	-	-	6	-	-	-
R-AC-7070	#10 X 1" HEX HEAD SEALING WASHER SCREW - 3000 PIECES	10.25	10.25	6	31	-	-	-
R-AC-7071	#10 X 1" HEX HEAD SEALING WASHER SCREW - 610 PIECES	4.25	3	6.50	5	-	-	-
R-AC-7072	#10 X 1.5" HEX HEAD SEALING WASHER SCREW - 400 PIECES	-	-	-	5	-	-	-
R-AC-7075-????	POP RIVET - 20 PIECES	-	-	-	-	-	-	-

PALLET TYPE: A = 46" x 54" x 5" B = 43.75" x 125" x 6.375"

STANDARDS & CERTIFICATIONS

ACCREDITATION AND TESTING

ProVia's metal roofing products are voluntarily third-party tested and certified, and meet or exceed stringent industry standards.

Pre-Finished, Shake and Slate

TEST TYPE	STANDARD	RATING
Wind Uplift	TAS 125 7 Fasteners - 180mph	Class 90
	TAS 125-03 5 Fasteners - 160mph	Class 60
	UL 580 4 Fasteners - 120mph	Class 30
Impact Resistance	UL 2218	Class 4
Corrosion Resistance	ASTM B117	Pass
Weather Resistance	ASTM G-154	Pass
Wind-Driven Rain	TAS 100-95	Pass
Foot Traffic Resistance	ANSI-FM4470 (2016)	Pass
Tensile Strength	ASTM E8/E8M-16a	Pass
Florida-HVHZ (Shake)	FL# 37381	Pass
Florida-HVHZ (Slate)	FL# 37870	Pass



Each of ProVia's metal roofing panel colors have been rated for solar reflectance, and these values are listed by the Cool Roof Rating Council (CRRC) at coolroofs.org.

The CRRC was created in 1998 to develop accurate and credible methods for evaluating and labeling the solar reflectance and thermal emittance (radiative properties) for roofing products, to support research, and serve as an educational resource for information on roofing.



At ProVia, we manufacture energy efficient products and exercises environmental stewardship by recycling, reducing pollution emissions and much more. In fact, our company has received repeated awards from the Environmental Protection Agency such as Partner of the Year - Sustained Excellence for outstanding efforts in energy savings.

ENERGY STAR certified roofing products must meet minimum initial and aged solar reflectance values. ProVia's metal roofing products are pending completion of this 3-year certification evaluation.



ProVia is a proud member of the Metal Roofing Alliance (MRA), which is the leading voice for companies and professionals involved in the residential metal roofing industry. An affiliate organization of the Metal Construction Association, the MRA is dedicated to helping homeowners make educated roofing decisions and connecting them with expert metal roofing professionals. As such, we support advocacy in building code and standards arenas, quality materials, installation and design using metal roofing.

PEACE-OF-MIND

LIFETIME LIMITED WARRANTY

ProVia's metal roofing products are backed by an **industry-leading Lifetime Limited Warranty**. Visit provia.com/warranty for more details.



“To serve, by caring for details in ways others won’t.” It’s not just our mission, but a way of letting our light shine every day at ProVia®. We continually strive to put these words into action by providing unmatched quality and service. The P-icon symbolizes each employee’s commitment to devoting the utmost care, pride and quality into each building product we manufacture...**it’s The Professional Way.**



© 2021 ProVia
R-MK-10200-20 | 03/21

Distributed by: